



Plastik Kablo Bağları

Plastic Cable Ties

Ürün Kodu Product Code	Tip Type	Ölçüler (BoyxEn) Dimensions (LxW) (mm)	Maks. Sıkma Çapı Max. Bundle Dia. (mm)	Min. Açılma Mukavemeti Min. Loop Tensile Strenght (kg.)	Amb. Mik. Pack. Qty (Adet/Pcs.)	Koli Mik. Carton Qty. (Adet/Pcs.)
8016330109	PCT 100 x 2.5 Beyaz / White	100 x 2.5	22	8	100	26.000
8016330110	PCT 100 x 2.5 Siyah / Black	100 x 2.5	22	8	100	26.000
8016330209	PCT 150 x 2.5 Beyaz / White	150 x 2.5	35	8	100	20.000
8016330210	PCT 150 x 2.5 Siyah / Black	150 x 2.5	35	8	100	20.000
8016330309	PCT 200 x 2.5 Beyaz / White	200 x 2.5	55	8	100	18.000
8016330310	PCT 200 x 2.5 Siyah / Black	200 x 2.5	55	8	100	18.000
8016330409	PCT 140 x 3.6 Beyaz / White	140 x 3.6	36	18	100	12.000
8016330410	PCT 140 x 3.6 Siyah / Black	140 x 3.6	36	18	100	12.000
8016330509	PCT 200 x 3.6 Beyaz / White	200 x 3.6	52	18	100	10.000
8016330510	PCT 200 x 3.6 Siyah / Black	200 x 3.6	52	18	100	10.000
8016330609	PCT 250 x 3.6 Beyaz / White	250 x 3.6	68	18	100	8.000
8016330610	PCT 250 x 3.6 Siyah / Black	250 x 3.6	68	18	100	8.000
8016330709	PCT 280 x 3.6 Beyaz / White	280 x 3.6	82	18	100	8.000
8016330710	PCT 280 x 3.6 Siyah / Black	280 x 3.6	82	18	100	8.000
8016330809	PCT 370 x 3.6 Beyaz / White	370 x 3.6	105	18	100	6.000
8016330810	PCT 370 x 3.6 Siyah / Black	370 x 3.6	105	18	100	6.000
8016331009	PCT 200 x 4.8 Beyaz / White	200 x 4.8	49	22	100	7.000
8016331010	PCT 200 x 4.8 Siyah / Black	200 x 4.8	49	22	100	7.000
8016331209	PCT 250 x 4.8 Beyaz / White	250 x 4.8	68	22	100	6.000
8016331210	PCT 250 x 4.8 Siyah / Black	250 x 4.8	68	22	100	6.000
8016331309	PCT 300 x 4.8 Beyaz / White	300 x 4.8	83	22	100	5.000
8016331310	PCT 300 x 4.8 Siyah / Black	300 x 4.8	83	22	100	5.000
8016331509	PCT 370 x 4.8 Beyaz / White	370 x 4.8	105	22	100	4.000
8016331510	PCT 370 x 4.8 Siyah / Black	370 x 4.8	105	22	100	4.000
8016331709	PCT 430 x 4.8 Beyaz / White	430 x 4.8	125	22	100	3.000
8016331710	PCT 430 x 4.8 Siyah / Black	430 x 4.8	125	22	100	3.000
8016332009	PCT 300 x 7.6 Beyaz / White	300 x 7.6	80	55	100	3.000
8016332010	PCT 300 x 7.6 Siyah / Black	300 x 7.6	80	55	100	3.000
8016332209	PCT 370 x 7.6 Beyaz / White	370 x 7.6	101	55	100	2.500
8016332210	PCT 370 x 7.6 Siyah / Black	370 x 7.6	101	55	100	2.500
8016332309	PCT 450 x 7.6 Beyaz / White	450 x 7.6	128	55	100	2.500
8016332310	PCT 450 x 7.6 Siyah / Black	450 x 7.6	128	55	100	2.500
8016332409	PCT 600 x 9.0 Beyaz / White	600 x 9.0	160	80	100	1.200
8016332410	PCT 600 x 9.0 Siyah / Black	600 x 9.0	160	80	100	1.200
8016332609	PCT 760 x 9.0 Beyaz / White	760 x 9.0	227	80	100	1.200
8016332610	PCT 760 x 9.0 Siyah / Black	760 x 9.0	227	80	100	1.200
8016332709	PCT 900 x 9.0 Beyaz / White	900 x 9.0	275	80	100	1.200
8016332710	PCT 900 x 9.0 Siyah / Black	900 x 9.0	275	80	100	1.200

- Siyah renkli kablo bağları UV (Ultraviyole) ışınlarına karşı dayanımlıdır.
- Black colored cable ties are UV (Ultraviolet) resistant.

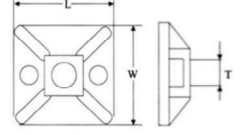

Yapışkan Krořeler

Self Adhesive Tie Mounts

Ürün Kodu Product Code	Tip Type	Ölçüler Dimensions (mm)			Amb. Mik. Pack. Qty (Adet/Pcs.)
		L	W	T	
8016333009	ATM 19 x 19 Beyaz / White	19	19	3,6	100
8016333010	ATM 19 x 19 Siyah / Black	19	19	3,6	100
8016333109	ATM 28 x 28 Beyaz / White	28	28	4,8	100
8016333110	ATM 28 x 28 Siyah / Black	28	28	4,8	100

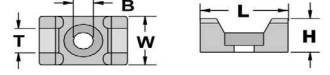

Vidalı Krořeler

Screw Type Tie Mounts

Ürün Kodu Product Code	Tip Type	Ölçüler Dimensions					Amb. Mik. Pack. Qty (Adet/Pcs.)
		L	W	H	T	B	
8016334009	STM 1 Beyaz / White	17,8	12,7	8,15	4,8	M3	100
8016334019	STM 2 Beyaz / White	25,4	16	10,8	9	M5	100



Kablo Bağı Aleti

Cable Tie Tool

Ürün Kodu Product Code	Tip Type	Özellik Function	Maks. Kablo Bağı Eni Max. Cable Tie Width (mm)	Amb. Mik. Pack. Qty (Adet/Pcs.)
8016334200	CTT1	Sıkma + Kesme Tightening + Cutting	4,8	1

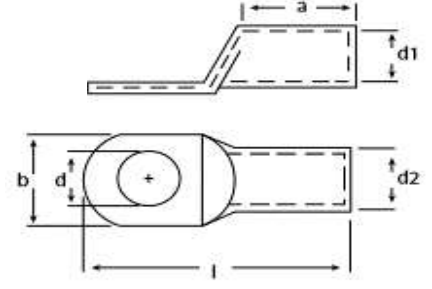

Eko Seri Sıklı Kablo Pabuları

Economical Compression Cable Lugs

Ürün Kodu Product Code	Tip Type	Kesit Cross Sec. (mm ²)	Ölüler / Dimensions (mm)						Delik apı Hole Dia.	Amb. Mik. Pack. Qty. (Adet/Pcs.)
			d	d1	d2	l	a	b		
8029320500	CCL-E 16 mm ² M6	16	6,5	5,5	7	32,5	11	10,5	M6	500
8029320510	CCL-E 16 mm ² M8	16	8,5	5,5	7	32,5	11	13	M8	500
8029320520	CCL-E 25 mm ² M8	25	8,5	7	9	38,5	16	13	M8	300
8029320530	CCL-E 35 mm ² M8	35	8,5	8,5	10,5	43,5	19	15,5	M8	200
8029320540	CCL-E 50 mm ² M10	50	10,5	10	12	51,5	21	17,6	M10	125
8029320550	CCL-E 70 mm ² M10	70	10,5	11,5	14	55,5	23	20,7	M10	100
8029320560	CCL-E 95 mm ² M12	95	10,5	13,5	16	58,5	26	23,5	M12	75
8029320570	CCL-E 120 mm ² M12	120	13	15,5	18	71	29	26,7	M12	50
8029320580	CCL-E 150 mm ² M12	150	13	16,5	20	76	30	29,2	M12	30
8029320590	CCL-E 185 mm ² M16	185	17	18,5	22	82	33	32,3	M16	25
8029320600	CCL-E 240 mm ² M16	240	17	21,5	25,5	91	38	37,6	M16	20

Malzeme : EN 13600 Standardında elektrolitik bakır
Kaplama : Minimum 3 mikron (µm) Kalay Kaplama

Material : EN 13600 Standarts Electrolytically Tin (E-Cu) Plated Copper
Plating : Minimum 3 microns (µm) Tin Plated



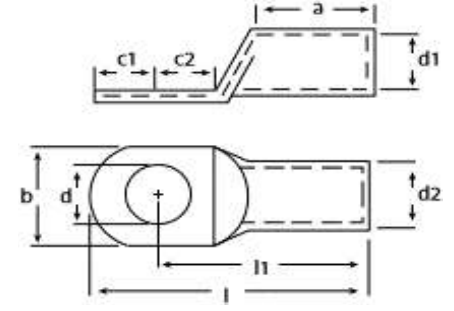

Standart Seri Sıkmalı Kablo Pabuçları

Standart Range Compression Lugs

Ürün Kodu Product Code	Tip Type	Kesit Cross Sec. (mm ²)	Ölçüler / Dimensions (mm)									Delik Çapı Hole Dia.	Amb. Mik. Pack. Qty. (Adet/Pcs.)
			d	d1	d2	l	l1	a	b	c1	c2		
8029320609	CCL 10mm ² M5	10	5,5	4,4	6	27,5	21,7	10	10,4	6	6	M5	500
8029320610	CCL 10mm² M6	10	6,5	4,4	6	27,5	21,7	10	10,4	6	6	M6	500
8029320620	CCL 10mm² M8	10	8,5	4,4	6	27,5	21,7	10	13,7	6	6	M8	500
8029320630	CCL 16mm² M6	16	6,5	5,5	8	32,6	24,9	12	11,4	7	8	M6	300
8029320640	CCL 16mm² M8	16	8,5	5,5	8	32,6	24,9	12	13,9	7	8	M8	300
8029320641	CCL 16mm ² M10	16	10,5	5,5	8	32,6	24,9	12	16,1	7	8	M10	300
8029320649	CCL 25mm ² M6	25	6,5	6,8	9	39	32,3	16	13,6	6,8	9,2	M6	200
8029320650	CCL 25mm² M8	25	8,5	6,8	9	39	32,3	16	13,7	6,8	9,2	M8	200
8029320651	CCL 25mm ² M10	25	10,5	7	9,5	42	34,1	16	16,1	6,8	11	M10	200
8029320659	CCL 35mm ² M6	35	6,5	8,2	11	44	35,6	19	15,9	8,3	9,7	M6	150
8029320660	CCL 35mm² M8	35	8,5	8,2	11	44	35,6	19	15,9	8,3	9,7	M8	150
8029320661	CCL 35mm ² M10	35	10,5	8,2	11	48	37,9	19	15,8	10	12	M10	150
8029320669	CCL 50mm ² M8	50	8,5	9,5	12	47,5	39,3	21	17,8	8,3	9,7	M8	100
8029320670	CCL 50mm² M10	50	10,5	9,5	12	51,5	41,6	21	17,9	10	12	M10	100
8029320671	CCL 50mm ² M12	50	13	10,1	13	51,5	41,6	21	19,2	10	12	M12	100
8029320672	CCL 50mm ² M14	50	15	10,1	13	56,5	44,6	21	20,7	12	15	M14	100
8029320679	CCL 70mm ² M8	70	8,5	11,2	14,5	54,6	44,5	23	21,2	10	12	M8	75
8029320680	CCL 70mm² M10	70	10,5	11,2	14,5	54,6	44,5	23	21,2	10	12	M10	75
8029320681	CCL 70mm ² M12	70	13	11,2	14,5	54,6	44,5	23	21,3	10	12	M12	75
8029320682	CCL 70mm ² M14	70	15	11,2	14,5	62,6	47,5	23	21,5	15	15	M14	75
8029320689	CCL 95mm ² M8	95	8,5	13,4	17	58,8	48,9	26	24,7	10	12	M8	50
8029320690	CCL 95mm² M10	95	10,5	13,4	17	58,8	48,9	26	24,7	10	12	M10	50
8029320700	CCL 95mm² M12	95	13	13,4	17	58,8	48,9	26	24,6	10	12	M12	50
8029320709	CCL 120mm ² M10	120	10,5	15,5	19	69	55,9	29	28,1	13	14,5	M10	40
8029320710	CCL 120mm² M12	120	13	15,5	19	69	55,9	29	28,2	13	14,5	M12	40
8029320711	CCL 120mm ² M16	120	17	15,5	19	69	55,9	29	28,2	13	14,5	M16	40
8029320719	CCL 150mm ² M10	150	10,5	16,5	16,5	76,5	59,9	30	30,2	16,5	16,5	M10	30
8029320720	CCL 150mm² M12	150	13	16,5	21	76,5	59,9	30	30,1	16,5	16,5	M12	30
8029320721	CCL 150mm ² M16	150	17	16,5	21	76,5	59,9	30	30,1	16,5	16,5	M16	30
8029320729	CCL 185mm ² M12	185	13	18,5	23	82,5	65,6	33	34,2	17	18	M12	25
8029320730	CCL 185mm² M16	185	17	18,5	23	82,5	65,6	33	34,1	17	18	M16	25
8029320739	CCL 240mm ² M12	240	13	21	26	89	72,1	38	38,2	17	18	M12	20
8029320740	CCL 240mm² M16	240	17	21	26	89	72,1	38	38,2	17	18	M16	20

Malzeme : EN 13600 Standardında elektrolitik bakır
Kaplama : Minimum 3 mikron (µm) Kalay Kaplama

Material : EN 13600 Standarts Electrolytically Tin (E-Cu) Plated Copper
Plating : Minimum 3 microns (µm) Tin Plated

** Koyu renk ile işaretlenmiş kablo pabuçları standart ürünlerimiz olup, diğer kalemler için lütfen stok durumunu sorunuz.

** **Bold colored Lugs items are our standart sizes, pls advise for other items stocks availability**

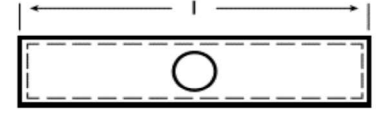

Eko Seri Ek Muflar

Economical Range Compression Butt Terminals

Ürün Kodu Product Code	Tip Type	Kesit Cross Sec. (mm ²)	Uzunluk Length (l) mm	Amb. Mik. Pack. Qty. (Adet/Pcs.)
8029320750	CBT-E 16 mm ²	16	32	300
8029320760	CBT-E 25 mm ²	25	41	200
8029320770	CBT-E 35 mm ²	35	46	150
8029320780	CBT-E 50 mm ²	50	54	125
8029320790	CBT-E 70 mm ²	70	58	100
8029320800	CBT-E 95 mm ²	95	62	60
8029320810	CBT-E 120 mm ²	120	74	40
8029320820	CBT-E 150 mm ²	150	80	30
8029320830	CBT-E 185 mm ²	185	86	22
8029320840	CBT-E 240 mm ²	240	95	15

Malzeme : EN 13600 Standardında elektrolitik bakır
Kaplama : Minimum 3 mikron (µm) Kalay Kaplama

Material : EN 13600 Standarts Electrolytically Tin (E-Cu) Plated Copper
Plating : Minimum 3 microns (µm) Tin Plated

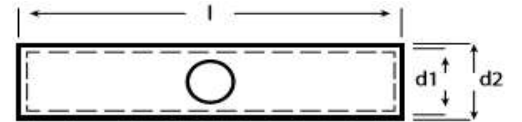

Standart Seri Ek Muflar

Standard Range Compression Butt Terminals

Ürün Kodu Product Code	Tip Type	Kesit Cross Sec. (mm ²)	Ölçüler / Dimensions (mm)			Amb. Mik. Pack. Qty. (Adet/Pcs.)
			d1	d2	l	
8029320845	CBT 10 mm ²	10	4,4	6	27	400
8029320850	CBT 16 mm ²	16	5,5	8	32	250
8029320860	CBT 25 mm ²	25	7	9	40,5	200
8029320870	CBT 35 mm ²	35	8,2	11	45,5	150
8029320880	CBT 50 mm ²	50	9,5	13	53,5	80
8029320890	CBT 70 mm ²	70	11,2	14,5	57,5	60
8029320900	CBT 95 mm ²	95	13,4	17	61,5	40
8029320910	CBT 120 mm ²	120	15	19,5	74	30
8029320920	CBT 150 mm ²	150	16,5	21	79	25
8029320930	CBT 185 mm ²	185	19	24	85	18
8029320940	CBT 240 mm ²	240	21	26	95	13

Malzeme : EN 13600 Standardında elektrolitik bakır
Kaplama : Minimum 3 mikron (µm) Kalay Kaplama

Material : EN 13600 Standarts Electrolytically Tin (E-Cu) Plated Copper
Plating : Minimum 3 microns (µm) Tin Plated

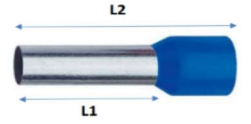

İzoleli Kablo Yüksükleri

Insulated End Sleeves

Ürün Kodu Product Code	Tip Type	Ölçüler Dimensions (mm)		Kesit Cross Sect. (mm ²)	AWG	Norm	Amb. Mik. Pack. Qty (Adet/Pcs.)
		L1	L2				
8017335000	IES 0,50/8 Turuncu / Orange	8	12	0,5	20	Alman / German	1.000
8017335010	IES 0,75/8 Beyaz / White	8	14	0,75	18	Alman / German	1.000
8017335020	IES 1,0/8 Sarı / Yellow	8	14	1	17	Alman / German	1.000
8017335030	IES 1,5/8 Kırmızı / Red	8	14	1,5	16	Alman / German	1.000
8017335040	IES 2,5/8 Mavi / Blue	8	14	2,5	14	Alman / German	500
8017335050	IES 4,0/10 Gri / Grey	10	17	4	12	Alman / German	500
8017335060	IES 6,0/12 Siyah / Black	12	20	6	10	Alman / German	250
8017335070	IES 10,0/12 Fildişi / Ivory	12	22	10	8	Alman / German	100
8017335080	IES 16,0/12 Yeşil / Green	12	24	16	6	Alman / German	100
8017335090	IES 25,0/16 Kahve / Brown	16	28	25	4	Alman / German	50
8017335100	IES 35,0/16 Bej / Beige	16	30	35	2	Alman / German	50
8017335110	IES 50,0/20 Zeytin Yeşili / Olive Green	20	36	50	1	Alman / German	25

Ürün Kodu Product Code	Tip Type	Ölçüler Dimensions (mm)		Kesit Cross Sect. (mm ²)	AWG	Norm	Amb. Mik. Pack. Qty (Adet/Pcs.)
		L1	L2				
8017335005	IES 0,50/8 Beyaz / White	8	12	0,5	20	Fransız / French	1.000
8017335015	IES 0,75/8 Mavi / Blue	8	14	0,75	18	Fransız / French	1.000
8017335025	IES 1,0/8 Kırmızı / Red	8	14	1	17	Fransız / French	1.000
8017335035	IES 1,5/8 Siyah / Black	8	14	1,5	16	Fransız / French	1.000
8017335045	IES 2,5/8 Gri / Grey	8	14	2,5	14	Fransız / French	500
8017335055	IES 4,0/10 Turuncu / Orange	10	17	4	12	Fransız / French	500
8017335065	IES 6,0/12 Yeşil / Green	12	20	6	10	Fransız / French	250
8017335075	IES 10,0/12 Kahve / Brown	12	22	10	8	Fransız / French	100
8017335085	IES 16,0/12 Bej / Beige	12	24	16	6	Fransız / French	100
8017335095	IES 25,0/16 Siyah / Black	16	28	25	4	Fransız / French	50
8017335105	IES 35,0/16 Kırmızı / Red	16	30	35	2	Fransız / French	50
8017335115	IES 50,0/20 Mavi / Blue	20	36	50	1	Fransız / French	25



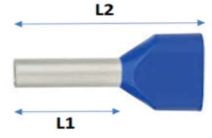

Çift Girişli Kablo Yüksükleri

Twin Cord End Sleeves

Ürün Kodu Product Code	Tip Type	Ölçüler Dimensions (mm)		Kesit Cross Sect. (mm ²)	Norm	Amb. Mik. Pack. Qty (Adet/Pcs.)
		L1	L2			
8017335400	IES 2x0,50/8 Turuncu / Orange	8	14	2 x 0,5	Alman / German	1.000
8017335410	IES 2x0,75/8 Beyaz / White	8	14	2 x 0,75	Alman / German	500
8017335420	IES 2x1,0/8 Sarı / Yellow	8	14	2 x 1,0	Alman / German	500
8017335430	IES 2x1,5/8 Kırmızı / Red	8	14	2 x 1,5	Alman / German	500
8017335440	IES 2x2,5/10 Mavi / Blue	10	14	2 x 2,5	Alman / German	250
8017335450	IES 2x4,0/12 Gri / Grey	12	17	2 x 4,0	Alman / German	200
8017335460	IES 2x6,0/14 Siyah / Black	14	20	2 x 6,0	Alman / German	100
8017335470	IES 2x10,0/14 Fildişi / Ivory	14	27	2 x 10	Alman / German	50
8017335480	IES 2x16,0/14 Yeşil / Green	14	31	2 x 16	Alman / German	50

Ürün Kodu Product Code	Tip Type	Ölçüler Dimensions (mm)		Kesit Cross Sect. (mm ²)	Norm	Amb. Mik. Pack. Qty (Adet/Pcs.)
		L1	L2			
8017335405	IES 2x0,50/8 Beyaz / White	8	14	2 x 0,5	Fransız / French	1.000
8017335415	IES 2x0,75/8 Mavi / Blue	8	14	2 x 0,75	Fransız / French	500
8017335425	IES 2x1,0/8 Kırmızı / Red	8	14	2 x 1,0	Fransız / French	500
8017335435	IES 2x1,5/8 Siyah / Black	8	14	2 x 1,5	Fransız / French	500
8017335445	IES 2x2,5/10 Gri / Grey	10	14	2 x 2,5	Fransız / French	250
8017335455	IES 2x4,0/12 Turuncu / Orange	12	17	2 x 4,0	Fransız / French	200
8017335465	IES 2x6,0/14 Yeşil / Green	14	20	2 x 6,0	Fransız / French	100
8017335475	IES 2x10,0/14 Kahve / Brown	14	27	2 x 10	Fransız / French	50
8017335485	IES 2x16,0/14 Bej / Beige	14	31	2 x 16	Fransız / French	50

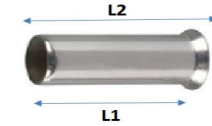

İzolesiz Kablo Yüksükleri

Non-insulated End Sleeves

Ürün Kodu Product Code	Tip Type	Ölçüler Dimensions (mm)		Kesit Cross Sect. (mm ²)	AWG	Amb. Mik. Pack. Qty (Adet/Pcs.)
		L1	L2			
8017335220	ES 0,50/10	8	10	0,50	20	2.000
8017335230	ES 0,75/10	8	10	0,75	18	2.000
8017335240	ES 1,0/10	8	10	1,00	17	2.000
8017335250	ES 1,5/10	8	10	1,50	15	2.000
8017335260	ES 2,5/12	8	12	2,50	13	2.000
8017335270	ES 4,0/12	10	12	4,00	11	1.000
8017335280	ES 6,0/12	10	12	6,00	9	500
8017335290	ES 10,0/15	12	15	10,00	7	200
8017335300	ES 16,0/15	12	15	16,00	5	200
8017335310	ES 25,0/16	16	16	25,00	4	100
8017335320	ES 35,0/16	16	16	35,00	2	100
8017335330	ES 50,0/20	20	20	50,00	1	50

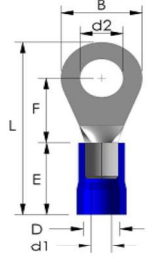

Yuvarlak Pabuçlar

Insulated Ring Terminals

Ürün Kodu Product Code	Tip Type	Kesit Cross Sect. (mm ²)	Ölçüler Dimensions (mm)							Renk Color	Amb. Mik. Pack. Qty (Adet/Pcs.)
			d2	B	F	L	E	D	d1		
8018335500	IRT 301	0,5 - 1,5	3,2	5,5	4	16,7	10	4,1	1,7	Kırmızı / Red	200
8018335510	IRT 351	0,5 - 1,5	3,7	5,5	4	16,7	10	4,1	1,7	Kırmızı / Red	200
8018335520	IRT 401	0,5 - 1,5	4,3	6,6	6,3	19,6	10	4,1	1,7	Kırmızı / Red	200
8018335530	IRT 501	0,5 - 1,5	5,3	8	7	21	10	4,1	1,7	Kırmızı / Red	200
8018335540	IRT 601	0,5 - 1,5	6,5	11,6	11,1	26,8	10	4,1	1,7	Kırmızı / Red	200
8018335550	IRT 801	0,5 - 1,5	8,4	11,6	11,1	26,8	10	4,1	1,7	Kırmızı / Red	200
8018335560	IRT 302	1,5 - 2,5	3,2	6,4	4,3	17,5	10	4,5	2,3	Mavi / Blue	200
8018335570	IRT 402	1,5 - 2,5	4,3	6,6	6,3	19,5	10	4,5	2,3	Mavi / Blue	200
8018335580	IRT 502	1,5 - 2,5	5,3	8,5	7,8	22	10	4,5	2,3	Mavi / Blue	200
8018335590	IRT 602	1,5 - 2,5	6,5	12	11	27	10	4,5	2,3	Mavi / Blue	200
8018335600	IRT 802	1,5 - 2,5	8,4	12	11	27	10	4,5	2,3	Mavi / Blue	200
8018335610	IRT 1002	1,5 - 2,5	10,5	13,6	13,9	30,7	10	4,5	2,3	Mavi / Blue	100
8018335620	IRT 406	4,0 - 6,0	4,3	7,2	5,9	22	12,5	6,5	3,4	Sarı / Yellow	75
8018335630	IRT 506	4,0 - 6,0	5,3	9,5	8,3	25,5	12,5	6,5	3,4	Sarı / Yellow	75
8018335640	IRT 606	4,0 - 6,0	6,5	12	10,5	29	12,5	6,5	3,4	Sarı / Yellow	75
8018335650	IRT 806	4,0 - 6,0	8,4	15	13,7	33,7	12,5	6,5	3,4	Sarı / Yellow	75
8018335660	IRT 1006	4,0 - 6,0	10,5	15	13,7	33,7	12,5	6,5	3,4	Sarı / Yellow	75
8018335670	IRT 1206	4,0 - 6,0	13	19,2	16	38,1	12,5	6,5	3,4	Sarı / Yellow	75
8018335680	IRT 510	8,0 - 10,0	5,3	12	9,7	32,5	17	8	4,5	Kırmızı / Red	50
8018335690	IRT 610	8,0 - 10,0	6,7	12	9,7	32,5	17	8	4,5	Kırmızı / Red	50

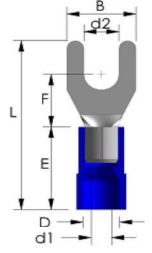

Çatal Pabuçlar

Insulated Fork Terminals

Ürün Kodu Product Code	Tip Type	Kesit Cross Sect. (mm ²)	Ölçüler Dimensions (mm)							Renk Color	Amb. Mik. Pack. Qty (Adet/Pcs.)
			d2	B	F	L	E	D	d1		
8018335700	IFT 301	0,5 - 1,5	3,2	5,8	6,3	21	10	4,1	1,7	Kırmızı / Red	200
8018335720	IFT 401	0,5 - 1,5	4,3	6,4	6,3	20,6	10	4,1	1,7	Kırmızı / Red	200
8018335730	IFT 501	0,5 - 1,5	5,3	8	7	21	10	4,1	1,7	Kırmızı / Red	200
8018335740	IFT 601	0,5 - 1,5	6,5	12	11	27,2	10	4,1	1,7	Kırmızı / Red	200
8018335750	IFT 352	1,5 - 2,5	3,2	5,8	6,3	21	10	4,2	2,3	Mavi / Blue	200
8018335760	IFT 402	1,5 - 2,5	4,3	6,4	6,3	21	10	4,2	2,3	Mavi / Blue	200
8018335770	IFT 502	1,5 - 2,5	5,3	9,5	7,2	22	10	4,2	2,3	Mavi / Blue	200
8018335780	IFT 602	1,5 - 2,5	6,5	12	11	27,2	10	4,2	2,3	Mavi / Blue	200
8018335790	IFT 406	4,0 - 6,0	4,3	8,5	7,5	25,2	12,5	6,5	3,4	Sarı / Yellow	75
8018335800	IFT 506	4,0 - 6,0	5,3	9,5	7,5	25,2	12,5	6,5	3,4	Sarı / Yellow	75
8018335810	IFT 606	4,0 - 6,0	6,5	9,5	7,5	25,2	12,5	6,5	3,4	Sarı / Yellow	75
8018335820	IFT 806	4,0 - 6,0	8,4	13,5	10,5	30	12,5	6,5	3,4	Sarı / Yellow	75

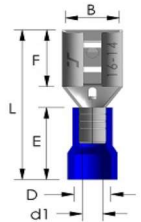

Faston Dişi Pabuçlar

Fast-on Female Terminals

Ürün Kodu Product Code	Tip Type	Kesit Cross Sect. (mm ²)	Ölçüler Dimensions (mm)						Renk Color	Amb. Mik. Pack. Qty (Adet/Pcs.)
			B	F	L	E	D	D1		
8018336030	FFT 1288	0,5 - 1,5	3,2	6,4	18,8	10	3,5	1,7	Kırmızı / Red	200
8018336100	FFT 1488	0,5 - 1,5	5	6,4	19,2	10	3,5	1,7	Kırmızı / Red	200
8018336110	FFT 1638	0,5 - 1,5	6,6	7,2	20,8	10	3,5	1,7	Kırmızı / Red	100
8018336120	FFT 2488	1,5 - 2,5	5	6,4	19,2	10	4,2	2,3	Mavi / Blue	200
8018336130	FFT 2638	1,5 - 2,5	6,6	7,2	20,8	10	4,2	2,3	Mavi / Blue	100
8018336140	FFT 5638	4,0 - 6,0	6,6	7,2	23,3	13	5,6	3,4	Sarı / Yellow	100

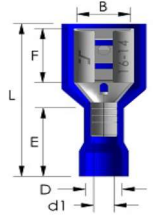

İzoleli Faston Dişi Pabuçlar

Insulated Fast-on Female Terminals

Ürün Kodu Product Code	Tip Type	Kesit Cross Sect. (mm ²)	Ölçüler Dimensions (mm)						Renk Color	Amb. Mik. Pack. Qty (Adet/Pcs.)
			B	F	L	E	D	D1		
8018336300	IFFT 1288	0,5 - 1,5	3,2	6,4	18,8	10	3,5	1,7	Kırmızı / Red	100
8018336310	IFFT 1488	0,5 - 1,5	5	6,4	19,2	10	3,5	1,7	Kırmızı / Red	100
8018336320	IFFT 1638	0,5 - 1,5	6,6	7,2	20,8	10	3,5	1,7	Kırmızı / Red	100
8018336330	IFFT 2488	1,5 - 2,5	5	6,4	19,2	10	4,2	2,3	Mavi / Blue	100
8018336340	IFFT 2638	1,5 - 2,5	6,6	7,2	20,8	10	4,2	2,3	Mavi / Blue	100
8018336350	IFFT 5638	4,0 - 6,0	6,6	7,2	23,8	13	5,6	3,4	Sarı / Yellow	75

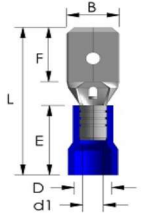

Faston Erkek Pabuçlar

Fast-on Male Terminals

Ürün Kodu Product Code	Tip Type	Kesit Cross Sect. (mm ²)	Ölçüler Dimensions (mm)						Renk Color	Amb. Mik. Pack. Qty (Adet/Pcs.)
			B	F	L	E	D	D1		
8018336150	FMT 1288	0,5 - 1,5	2,8	6,5	18,7	10	3,5	1,7	Kırmızı / Red	200
8018336160	FMT 1488	0,5 - 1,5	4,8	6,7	19,3	10	3,5	1,7	Kırmızı / Red	200
8018336170	FMT 1638	0,5 - 1,5	6,3	7,7	20,8	10	3,5	1,7	Kırmızı / Red	100
8018336180	FMT 2488	1,5 - 2,5	4,8	6,7	19,3	10	4,2	2,3	Mavi / Blue	200
8018336190	FMT 2638	1,5 - 2,5	6,3	7,7	20,8	10	4,2	2,3	Mavi / Blue	100
8018336200	FMT 5638	4,0 - 6,0	6,3	7,7	24	13	5,6	3,4	Sarı / Yellow	100

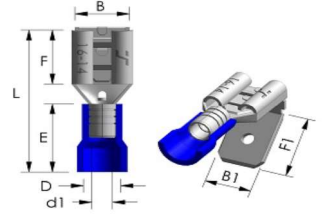

Geri Dönüflü Pabuçlar

Piggy Back Terminals

Ürün Kodu Product Code	Tip Type	Kesit Cross Sect. (mm ²)	Ölçüler Dimensions (mm)								Renk Color	Amb. Mik. Pack. Qty (Adet/Pcs.)
			B	B1	F	F1	L	E	D	D1		
8018336460	PBT 1638	0,5 - 1,5	6,6	6,3	8	8,2	22	10	3,5	1,7	Kırmızı / Red	100
8018336470	PBT 2638	1,5 - 2,5	6,6	6,3	8	8,2	22	10	4,2	2,3	Mavi / Blue	100
8018336480	PBT 5638	4,0 - 6,0	6,6	6,3	8	8,2	25	13	5,6	3,4	Sarı / Yellow	75

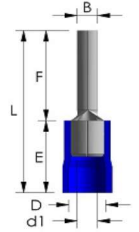

İğne Tip Pabuçlar

Insulated Pin Terminals

Ürün Kodu Product Code	Tip Type	Kesit Cross Sect. (mm ²)	Ölçüler Dimensions (mm)						Renk Color	Amb. Mik. Pack. Qty (Adet/Pcs.)
			B	F	L	E	D	D1		
8018335900	IPT 1/1,5	0,5 - 1,5	1,9	12	22	10	4,3	1,7	Kırmızı / Red	200
8018335910	IPT 1/2,5	1,5 - 2,5	1,9	12	22	10	4,8	2,3	Mavi / Blue	200
8018335920	IPT 1/6	4,0 - 6,0	2,8	14	28	13	6,2	3,4	Sarı / Yellow	100

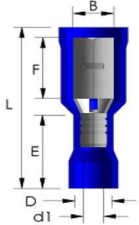

Dişi Pabuçlar

Bullet Female Terminals

Ürün Kodu Product Code	Tip Type	Kesit Cross Sect. (mm ²)	Ölçüler Dimensions (mm)						Renk Color	Amb. Mik. Pack. Qty (Adet/Pcs.)
			B	F	L	E	D	D1		
8018336600	BFT 1040	0,5 - 1,5	3,9	7,3	23,5	10	3,5	1,7	Kırmızı / Red	100
8018336610	BFT 2050	1,5 - 2,5	4,9	8,5	25	10	4,2	2,3	Mavi / Blue	100
8018336620	BFT 5050	4,0 - 6,0	4,9	8,5	28	13	5,6	3,4	Sarı / Yellow	50

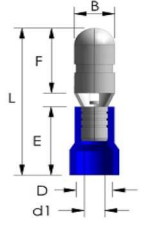

Erkek Pabuçlar

Bullet Male Terminals

Ürün Kodu Product Code	Tip Type	Kesit Cross Sect. (mm ²)	Ölçüler Dimensions (mm)						Renk Color	Amb. Mik. Pack. Qty (Adet/Pcs.)
			B	F	L	E	D	D1		
8018336700	BMT 1040	0,5 - 1,5	4	8,5	21	10	3,5	1,7	Kırmızı / Red	100
8018336710	BMT 2050	1,5 - 2,5	5	9	21,5	10	4,2	2,3	Mavi / Blue	100
8018336720	BMT 5050	4,0 - 6,0	5	9	24,5	13	5,6	3,4	Sarı / Yellow	100

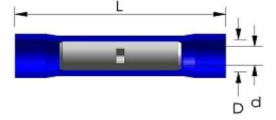

Ek Muflar

Insulated Butt Terminals

Ürün Kodu Product Code	Tip Type	Kesit Cross Sect. (mm ²)	Ölçüler Dimensions (mm)			Renk Color	Amb. Mik. Pack. Qty (Adet/Pcs.)
			L	D	d		
8018336500	IBT 251	0,5 - 1,5	24,5	4,3	1,7	Kırmızı / Red	100
8018336510	IBT 252	1,5 - 2,5	24,5	4,8	2,3	Mavi / Blue	100
8018336520	IBT 256	4,0 - 6,0	27	6,2	3,4	Sarı / Yellow	75