

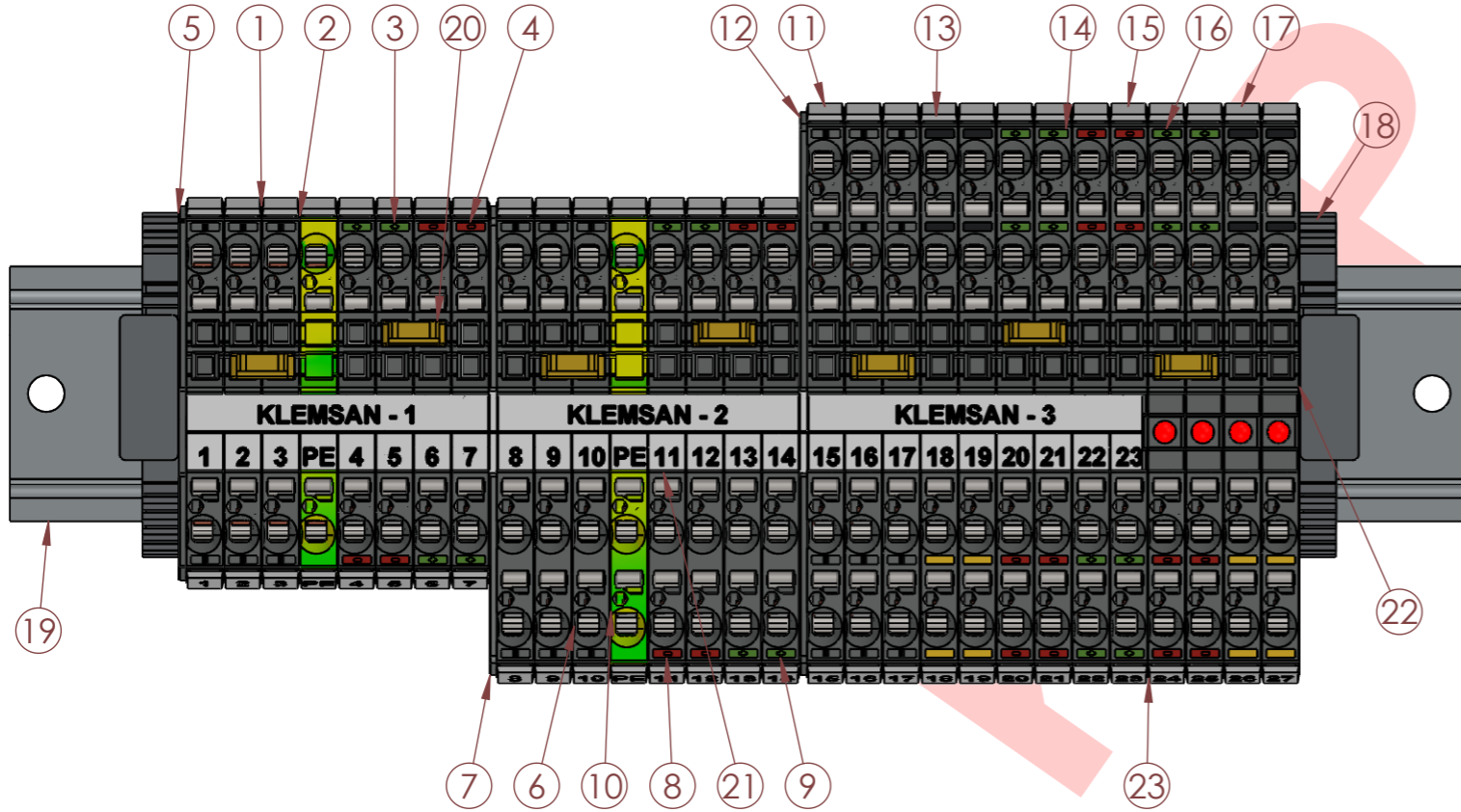

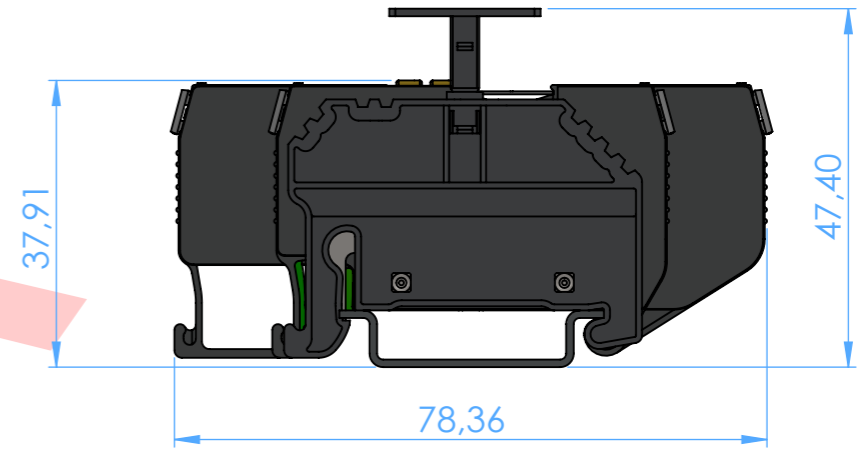

ATTENTION  
All information contained in this document is the exclusive property of KLEMSAN and may neither be used nor disclosed without its prior written consent. Parts manufactured to this drawing may not be given to third parties without the prior written consent of KLEMSAN.  
DO NOT SCALE REVISE ONLY ON CAD NO MODIFICATIONS PERMITTED

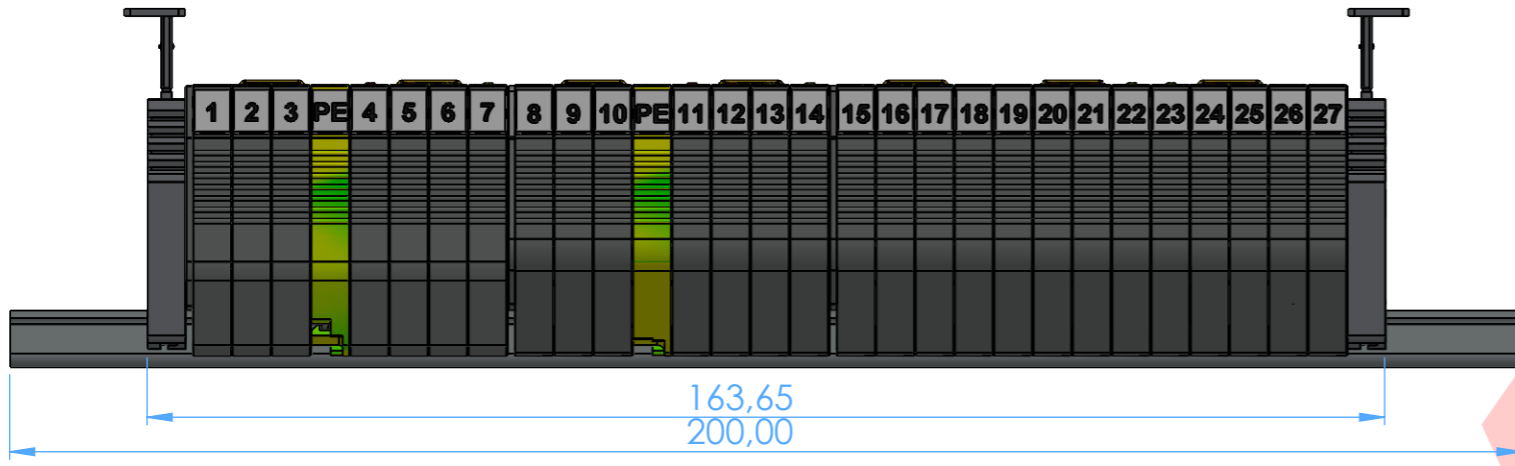

NO.	QTY.	PART NAME	PART NUMBER
23	58	DGO 6 X 5 (OZEL) BEYAZ	0.1.0.0.505370
22	2	ME 4 (GRI)	0.1.0.0.496329
21	1	SERIT ETIKET 11,2 (131mm)	2.8.0.4.000137
20	7	CS 2,5/2	0.1.0.0.470102
19	1	MR35x7,5 RAY 200 MM (DELIKLI) (CINKO KAPLI)	2.7.3.1.008212
18	2	KD 8 (GRI)	0.1.0.0.495229
17	2	SRD 2,5CLD-24VAC (GRI)	0.1.0.0.311169
16	2	SRD 2,5CLD-24VDC (GRI)	0.1.0.0.311159
15	2	SRD 2,5CD-B (GRI)	0.1.0.0.311139
14	2	SRD 2,5CD-A (GRI)	0.1.0.0.311129
13	2	SRD 2,5Cx2 (GRI)	0.1.0.0.311149
12	1	NPP_SRD 2,5C GRI	0.1.0.0.451189
11	3	SRD 2,5C (GRI)	0.1.0.0.311119
10	1	SRD 2,5ET (SARI-YESIL)	0.1.0.0.337130
9	2	SRD 2,5ED-B (GRI)	0.1.0.0.311109
8	2	SRD 2,5ED-A (GRI)	0.1.0.0.311099
7	1	NPP_SRD 2,5E GRI	0.1.0.0.451159
6	3	SRD 2,5E (GRI)	0.1.0.0.311089
5	1	NPP_SRD_CTP_PTP 2,5 GRI	0.1.0.0.451059
4	2	SRD 2,5D_B (GRI)	0.1.0.0.311079
3	2	SRD 2,5D_A (GRI)	0.1.0.0.311069
2	1	SRD 2,5T (SARI-YESIL)	0.1.0.0.337120
1	3	SRD 2,5 (GRI)	0.1.0.0.311059

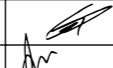
ADI - SOYADI NAME - SURNAME	TARİH DATE	İMZA SIGN	KAPLAMA PLATED	SERTLİK (Hv) HARDNESS (Hv)	AĞIRLIK (KG) MASS (KG)	 ELEKTRİK ELEKTRONİK SAN. ve TİC. A.Ş. www.klemsan.com.tr	MIKTAR QUANTITY	SAYFA NO PAGE NR
G.GÜLSEVER	12.10.2018				0.33111155			1/1
S.SERVÜZ	12.10.2018		MALZEME MATERIAL	MALZEME STOK KODU MATERIAL STOCK CODE				
M.AKAY	12.10.2018							
PROJE GRUBU/TİPİ PRODUCT GROUP/TYPE		PARÇA/MONTAJ ADI PART/ASSEMBLY NAME		RESİM NO DRAWING NO	REV. NO	ANTET FORMAT		
OZEL SETLER ONAYLANMIS_SETLER		SRD 2.5 SERISI SET		0.0.0.9.00237	01	A3		

NOT: ME 4 parçalar demonte şekilde setin yanına konulacaktır.